

MARKET B × ezbo

EZBO BESIDE 8문 수납장 세로형

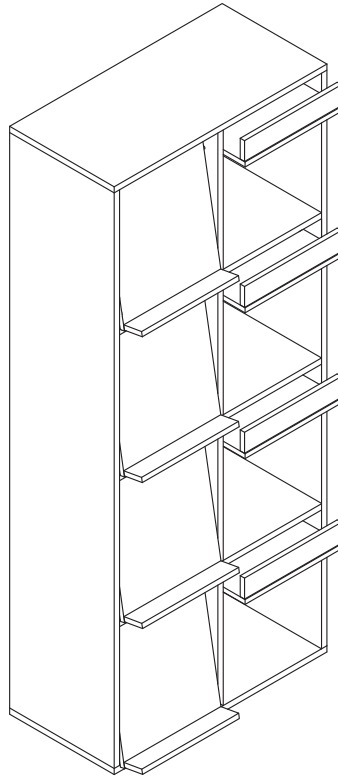

[취급주의]

- 가구사용시 임의적으로 휘발성있는 물질을 흘렸을 경우 가구표면의 손상이 발생하오니 주의하세요.
- 무리한 힘이나 충격을 가하지 마시고 수평을 유지하여 사용하세요.
- 직사광선이나 강한열 혹은 혹한을 피하여 주세요.
- 이동시 끌지마시고 들어서 이동하여 주세요.
- 테이프나 접착용품은 제품에 훼손을 일으킬수 있으니 주의하세요.
- 교환/취소/반품/환불 관련사항은 사이트 참조바랍니다.

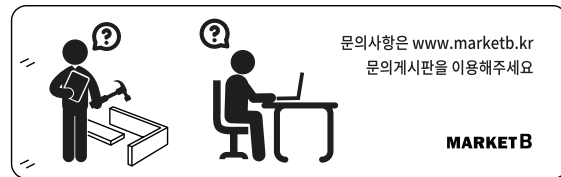
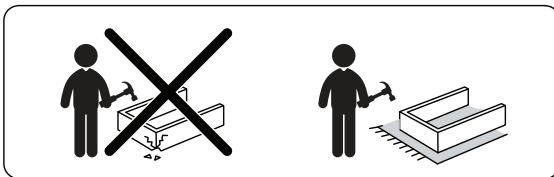

TIP

조립전 부품의 이상유무를 반드시 확인해주세요

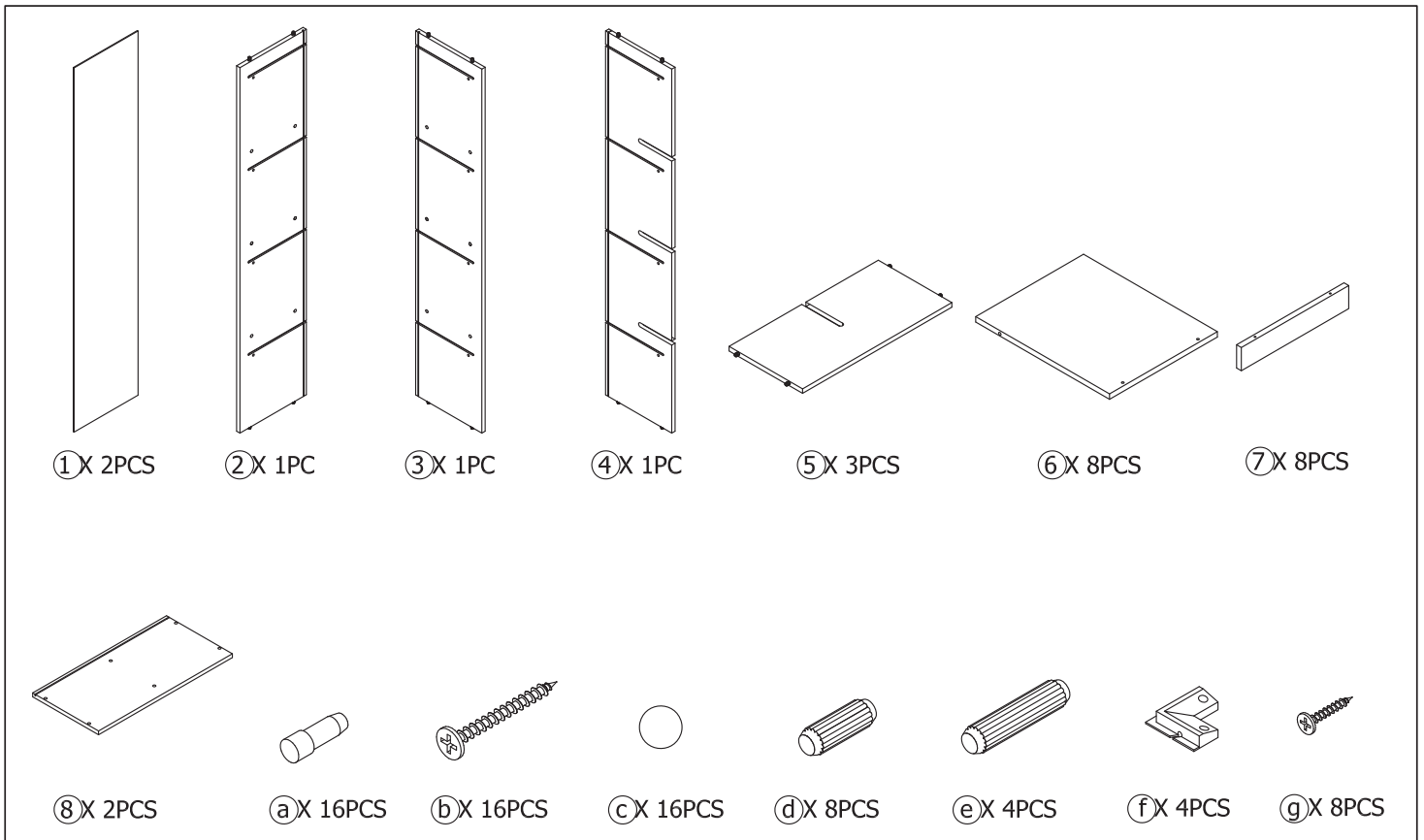
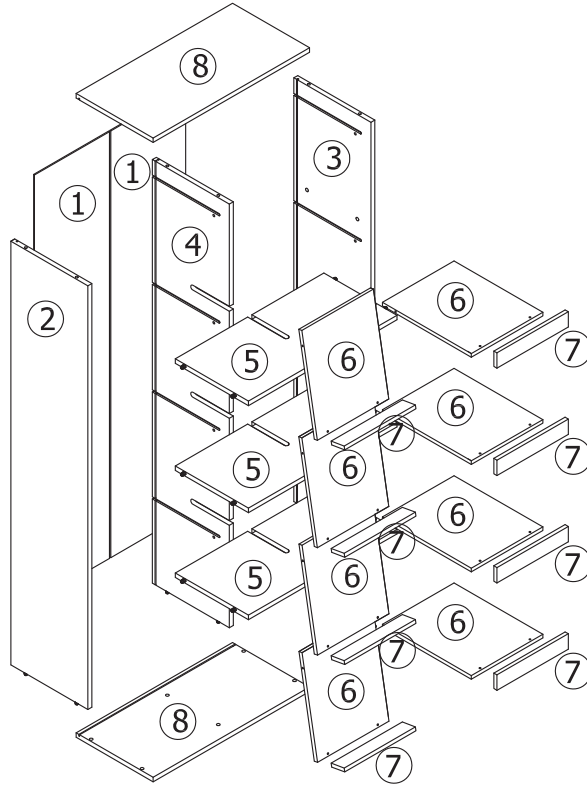

MARKET B

1

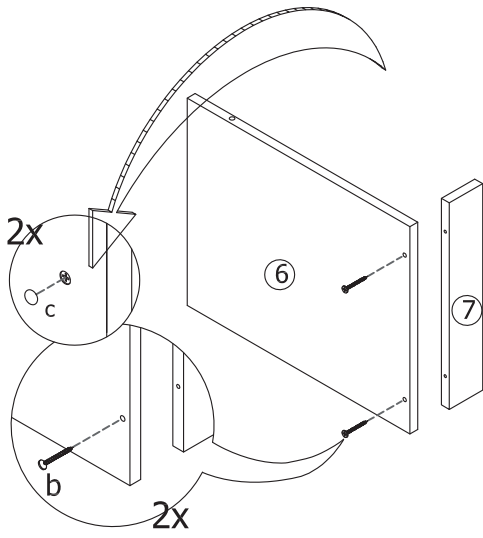

8x

2

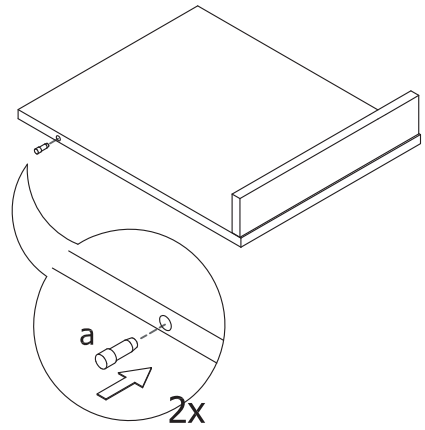

8x

3

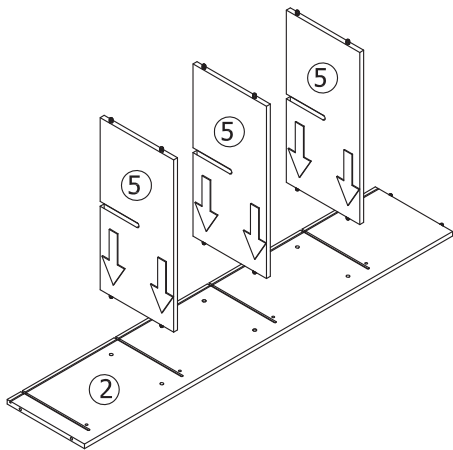

4

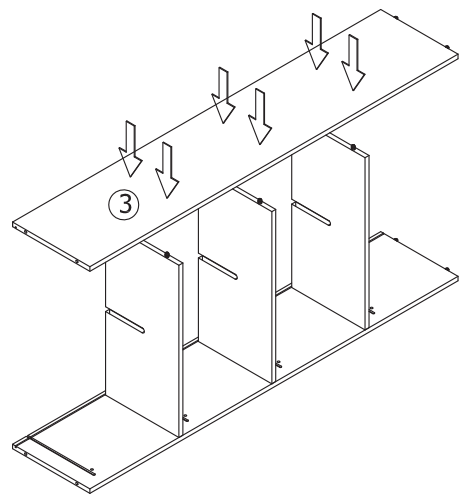

5

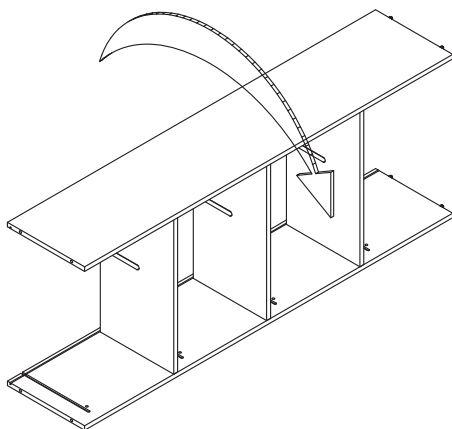

6

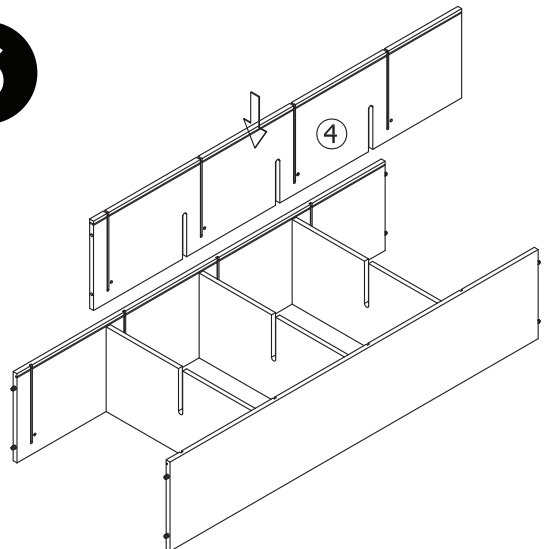

그림과 같이 다음 단계 조립을 위해 90° 돌려주세요.

MARKET B

7

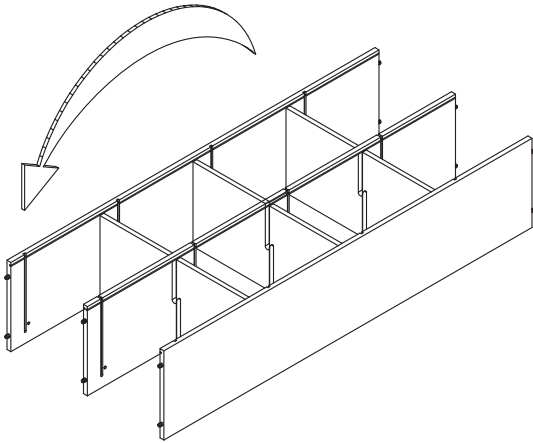

그림과 같이 다음 단계 조립을 위해 90° 돌려주세요.

8

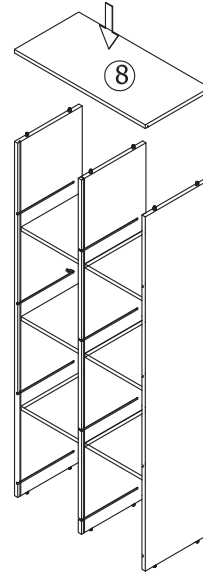

9

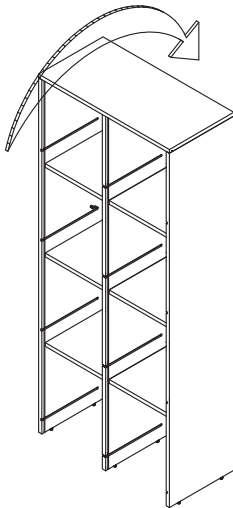

그림과 같이 다음 단계 조립을 위해 180° 돌려주세요.

10

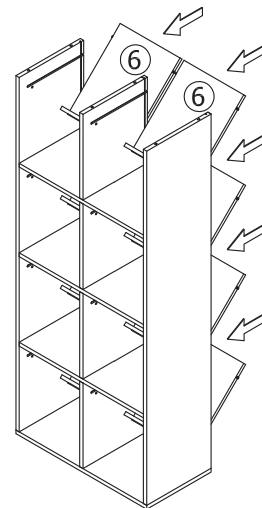

11

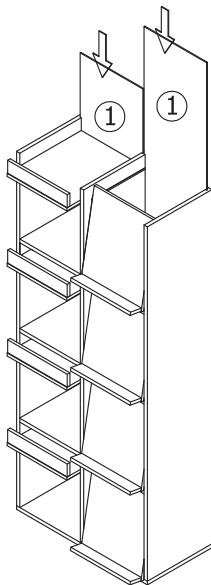

12

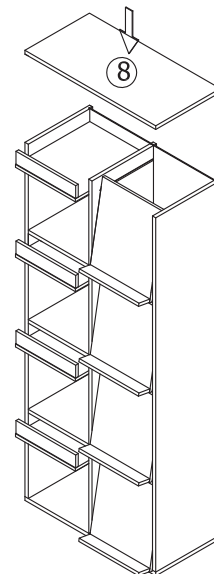

MARKET B

13

수납장 양쪽판 [2번, 3번]에 D목봉(짧은)을 조립합니다.

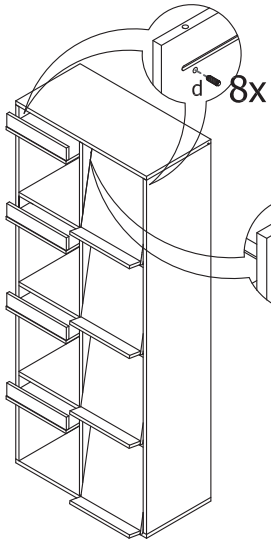

수납장 중간판 4번에 E목봉(긴)을 조립합니다.

※중간판 양쪽으로 목봉이 균등하게 나오도록 위치를 조정해주세요.

14

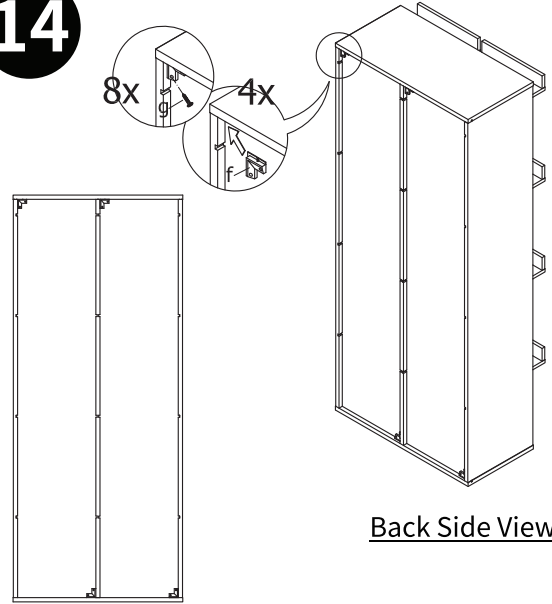

15

